

A-A SECTION

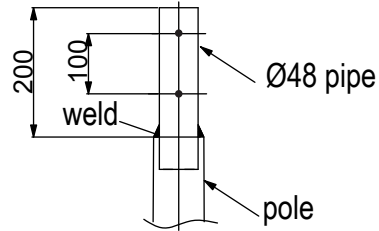

C-C SECTION

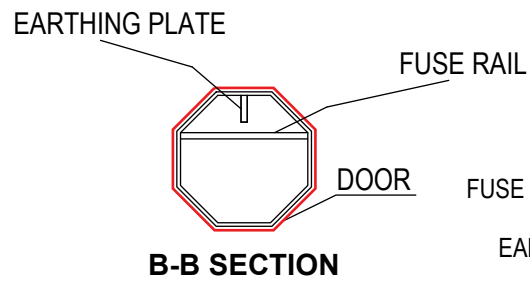

B-B SECTION

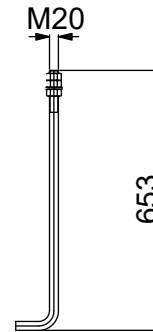
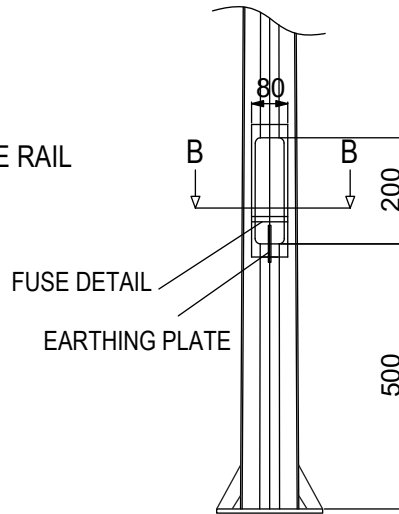

4 x M20 x 720 Anchor Bolts

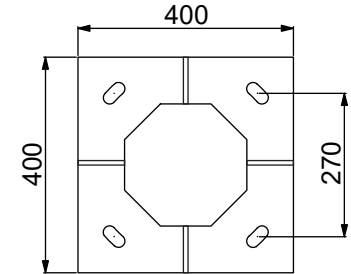

BASE PLATE
16mm x 400 x 400

All Dimensions are in mm	
St 37 - S235JR - EN 10025 <input checked="" type="checkbox"/>	St 52 - S355JR Steel <input type="checkbox"/>
AISI 304 Stainless Steel <input type="checkbox"/>	AISI 316 / Stainless Steel <input type="checkbox"/>
Surface Coating	
Hot Dip Galv. EN ISO 1461 <input checked="" type="checkbox"/>	Powder Coat <input type="checkbox"/>
Hot Dip Galvanized Standard EN ISO 1461-TS914	
Standard Steel EN 10025	
Bolts Standard: ISO 898.1/5.8	
професионално CETUS LED осветлување	Wind static : 110km/h
	Note :